

Parts

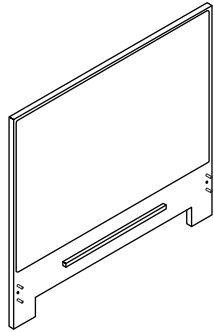

A - Headboard x 1

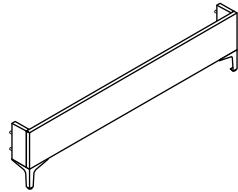

B - Footboard x 1

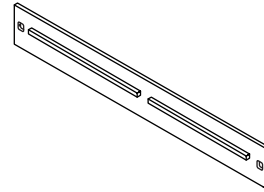

C - Side Rail x 2

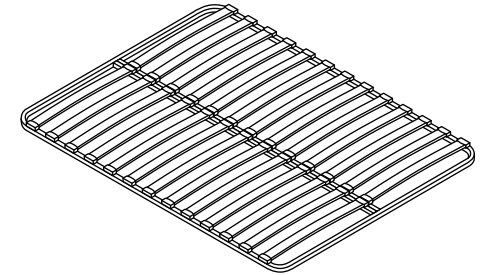

D - Metal Frame x 1



E - Leg
x 2

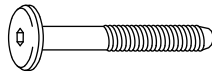

F - Bolt
x 4

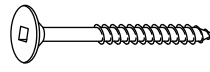

G - Screw
x 4

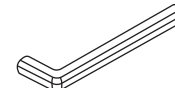

H - Allen Key
x 1



I - Felt Pad
x 12

1

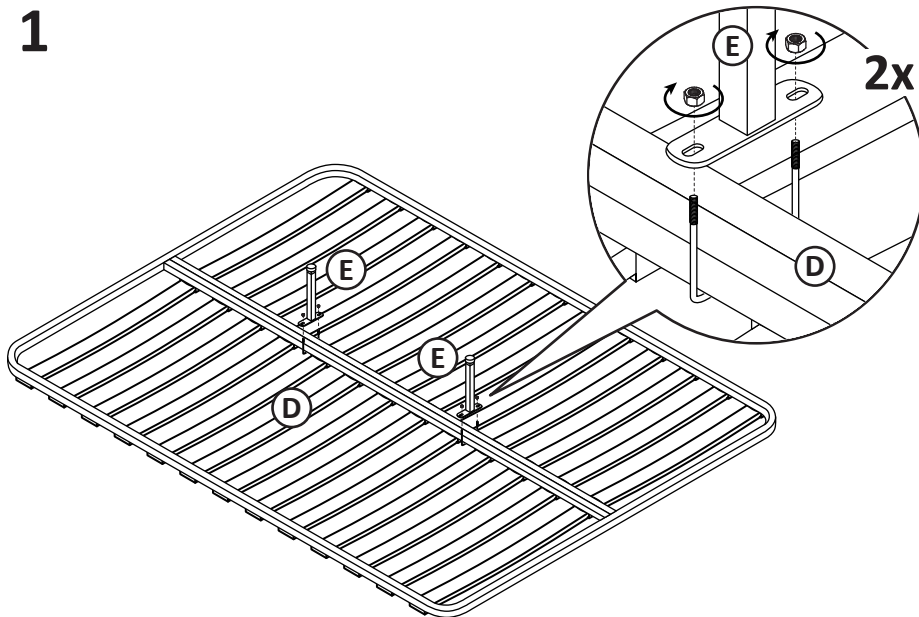

2

