

## Parts

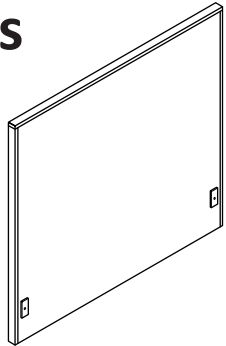

A - Headboard x 1

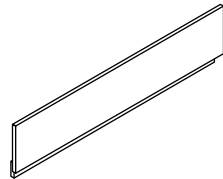

B - Footboard x 1

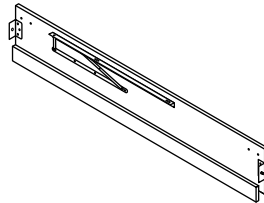

C - Side Rail x 2

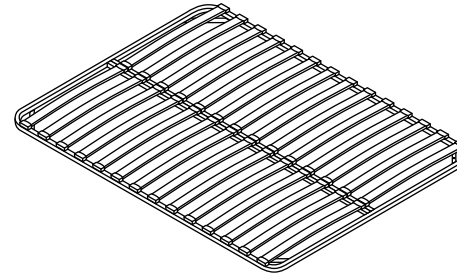

D - Metal Frame x 1

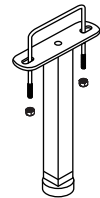

E - Leg x 2

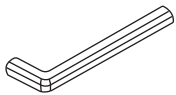

F - Allen Key  
x 1



G - Bolt  
x 8

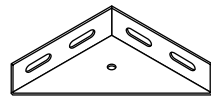

H - Corner Bracket  
x 2



I - Bolt & Nut  
x 6

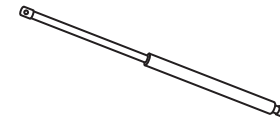

J - Hydraulic Piston  
x 2



K - Fabric Handle  
x 1

1

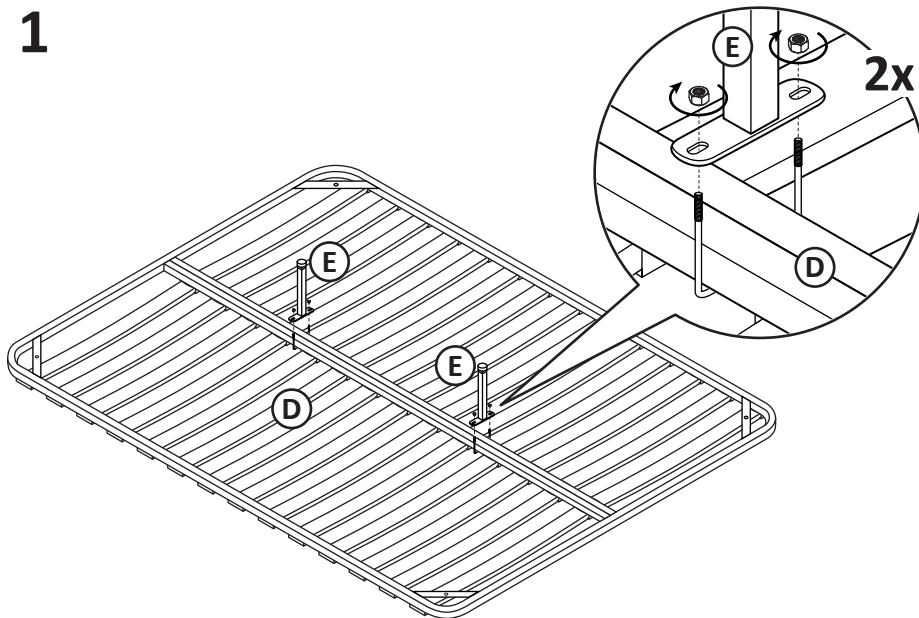

2

