

Parts

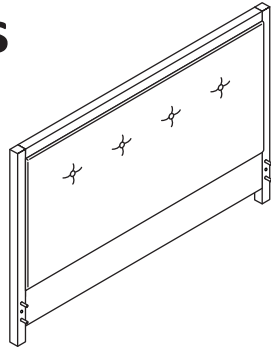

A - Headboard x 1

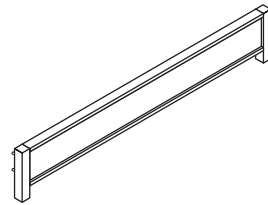

B - Footboard x 1

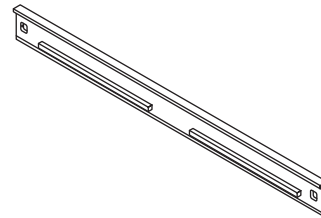

C - Side Rail x 2

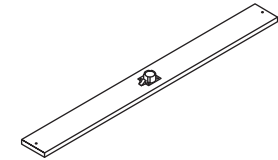

D - Wood Slats x 4

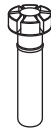

**E - Leg
x 4**

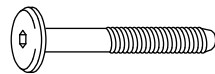

**F - Bolt
x 4**

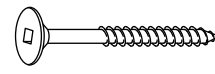

**G - Screw
x 8**

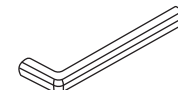

**H - Allen Key
x 1**

1

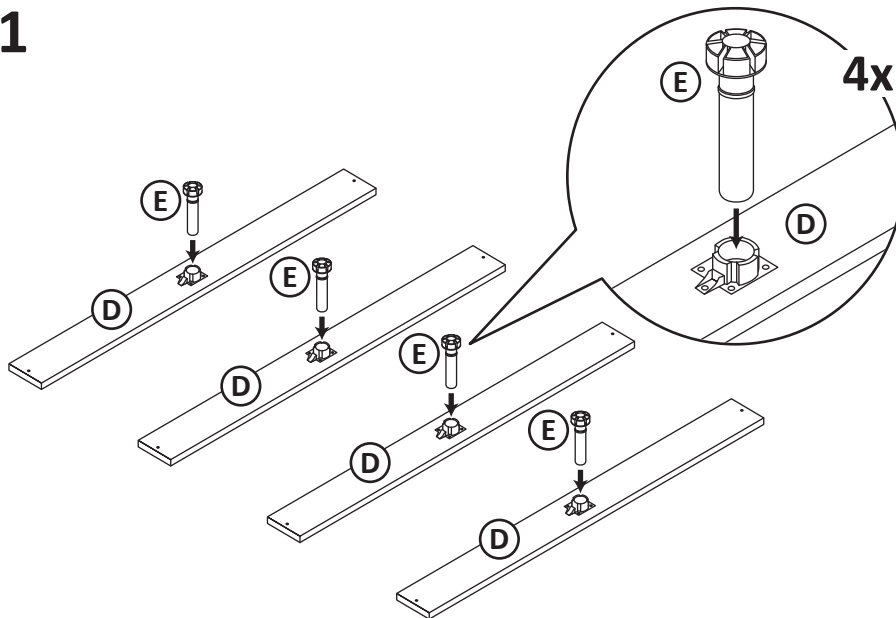

2

