

## Parts

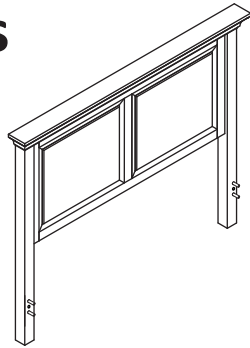

**A - Headboard x 1**

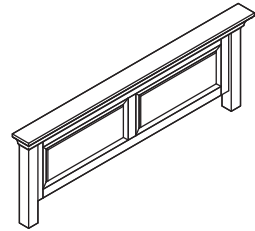

**B - Footboard x 1**

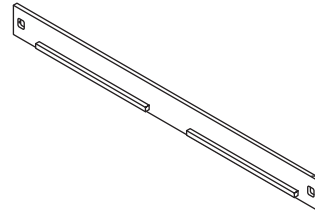

**C - Side Rail x 2**

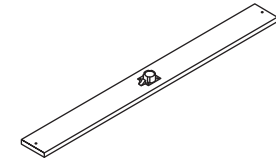

**D - Wood Slats x 4**

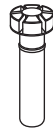

**E - Leg  
x 4**

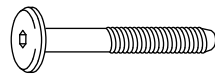

**F - Bolt  
x 4**

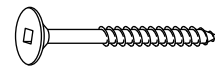

**G - Screw  
x 8**

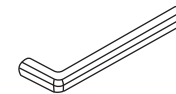

**H - Allen Key  
x 1**

**1**

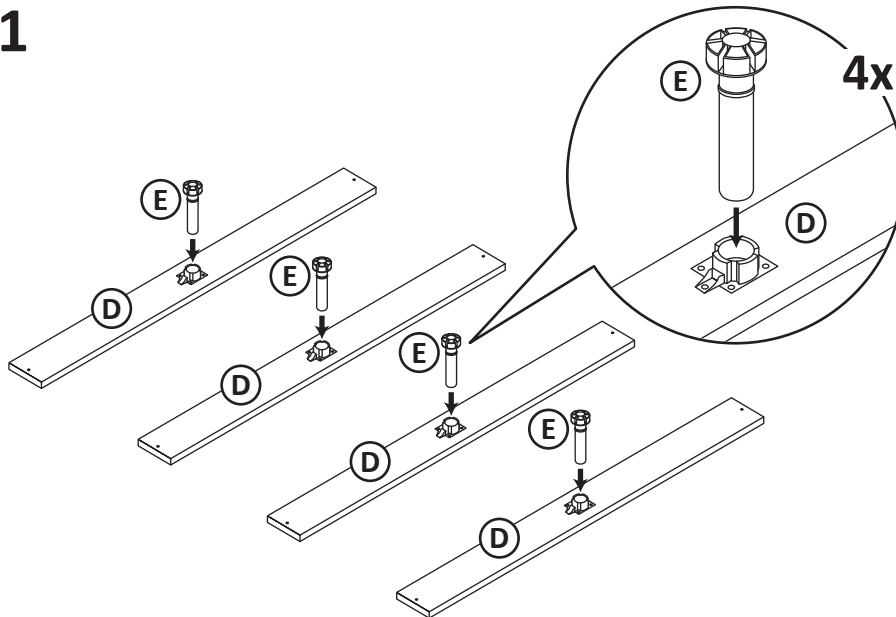

**2**

